

# Libe

SUSPENSION  
APPLIQUE

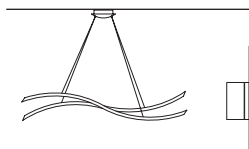

Telaio in metallo galvanizzato con diffusore in losanghe di cristallo opaco. Illuminazione LED.

Galvanised metal frame with a matt crystal lozenge diffuser. LED lighting.

Gestell aus galvanisch beschichtetem Metall mit Diffusor in matten Kristallrauten. LED-Leuchtmittel.

Marco de metal galvanizado con difusor en pastillas de cristal opaco. Iluminación LED.

Structure en métal galvanisé avec diffuseur en losanges en cristal mat. Éclairage à LED.

Каркас из оцинкованного металла с рассеивателем из пластин матового хрусталя. Светодиодный светильник.

电镀金属灯架，带不透明水晶菱形散光罩。LED 灯。

إطار معدني مجلفن مع ناشر من المعينات الكريستالية غير شفافة. الإنارة ليد.

## FINISHINGS

### STANDARD



G14 Ottone brunito  
Burnished brass

## STANDARD CABLES

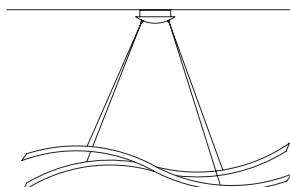

TRANSPARENT CABLE  
H 150 CM / 59.05"

**LIBE S160** 

W	160 cm / 63.00"
D	16 cm / 6.30"
H	30 cm / 11.80"
<b>STANDARD INTEGRATED LED LIGHTING</b>	
104 W CRI>90 3000 K – 9770 NOMINAL LM	
<b>ON REQUEST</b>	
104 W CRI>90 2700 K – 9280 NOMINAL LM	
<b>DIMMABLE</b>	
1-10V	

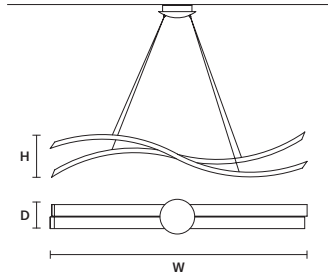

**LIBE S100** 

W	100 cm / 39.40"
D	16 cm / 6.30"
H	20 cm / 7.90"
<b>STANDARD INTEGRATED LED LIGHTING</b>	
63 W CRI>90 3000 K – 5922 NOMINAL LM	
<b>ON REQUEST</b>	
63 W CRI>90 2700 K – 5620 NOMINAL LM	
<b>DIMMABLE</b>	
0-10V	

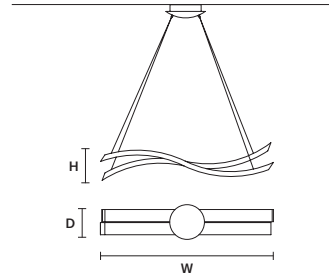

**LIBE ROUND S140** 

ø	140 cm / 55.10"
H	8,5 cm / 3.30"
<b>STANDARD INTEGRATED LED LIGHTING</b>	
144 W CRI>90 3000 K – 13536 NOMINAL LM	
<b>ON REQUEST</b>	
144 W CRI>90 2700 K – 12850 NOMINAL LM	
<b>DIMMABLE</b>	
1-10V	

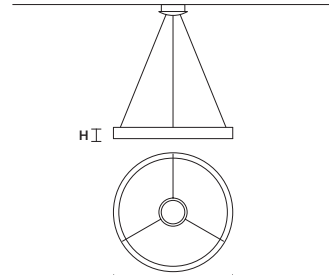

**LIBE COMBO S140** 

ø	140 cm / 55.10"
HMAX	300 cm / 118.00"
<b>STANDARD INTEGRATED LED LIGHTING</b>	
350 W CRI>90 3000 K – 32900 NOMINAL LM	
<b>ON REQUEST</b>	
350 W CRI>90 2700 K – 31230 NOMINAL LM	
<b>DIMMABLE</b>	
1-10V	

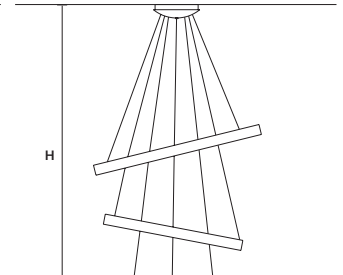

**LIBE ROUND S115** 

ø	115 cm / 45.30"
H	8,5 cm / 3.30"
<b>STANDARD INTEGRATED LED LIGHTING</b>	
116 W CRI>90 3000 K – 10904 NOMINAL LM	
<b>ON REQUEST</b>	
116 W CRI>90 2700 K – 10350 NOMINAL LM	
<b>DIMMABLE</b>	
1-10V	

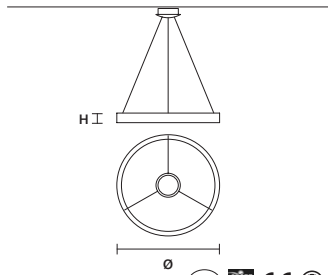

**LIBE ROUND S90** 

ø	90 cm / 35.40"
H	8,5 cm / 3.30"
<b>STANDARD INTEGRATED LED LIGHTING</b>	
90 W CRI>90 3000 K – 8460 NOMINAL LM	
<b>ON REQUEST</b>	
90 W CRI>90 2700 K – 8030 NOMINAL LM	
<b>DIMMABLE</b>	
0-10V	

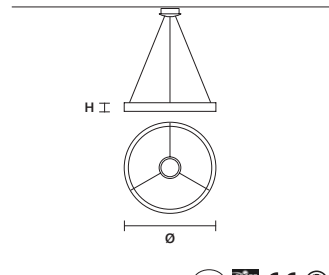

**LIBE ROUND S60** 

ø	60 cm / 23.60"
H	8,5 cm / 3.30"
<b>STANDARD INTEGRATED LED LIGHTING</b>	
59 W CRI>90 3000 K – 5546 NOMINAL LM	
<b>ON REQUEST</b>	
59 W CRI>90 2700 K – 5264 NOMINAL LM	
<b>DIMMABLE</b>	
0-10V	

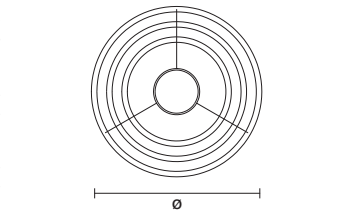
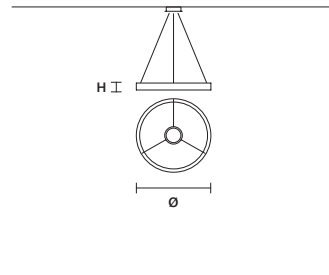

**LIBE ELLIPSE S120** 

W	120 cm / 47.20"
D	40 cm / 15.70"
H	8,5 cm / 3.30"
<b>STANDARD INTEGRATED LED LIGHTING</b>	
86,5 W CRI>90 3000 K – 8131 NOMINAL LM	
<b>ON REQUEST</b>	
86,5 W CRI>90 2700 K – 7720 NOMINAL LM	
<b>DIMMABLE</b>	
0-10V	

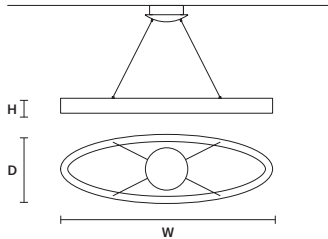

**LIBE ELLIPSE S90** 

W	90 cm / 35.40"
D	30 cm / 11.80"
H	8,5 cm / 3.30"
<b>STANDARD INTEGRATED LED LIGHTING</b>	
62,5 W CRI>90 3000 K – 5875 NOMINAL LM	
<b>ON REQUEST</b>	
62,5 W CRI>90 2700 K – 5580 NOMINAL LM	
<b>DIMMABLE</b>	
0-10V	

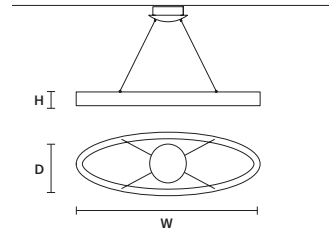

 : for the US market, refer to the relevant price list.

## LIBE A55



W	55 cm / 21.70"
D	8 cm / 3.10"
H	8,5 cm / 3.30"

## STANDARD INTEGRATED LED LIGHTING

7 W CRI>90  
3000 K – 658 NOMINAL LM

## ON REQUEST

7 W CRI>90  
2700 K – 625 NOMINAL LM

## DIMMABLE

NO

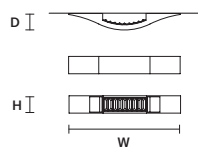

## SINGLE CANOPY

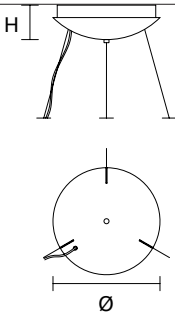
	SIZE	FINISHINGS	PRODUCT NAME
	Ø 27,5 cm / 10.80"	● G14	LIBE ROUND S140
	H 9 cm / 3.50"		LIBE ROUND S115
			LIBE ROUND S90
			LIBE ROUND S60

## SINGLE CANOPY

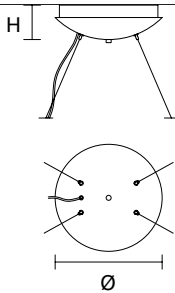
	SIZE	FINISHINGS	PRODUCT NAME
	Ø 27,5 cm / 10.80"	● G14	LIBE S100
	H 9 cm / 3.50"		LIBE S160
			LIBE ELLIPSE S90
			LIBE ELLIPSE S120

## SINGLE CANOPY

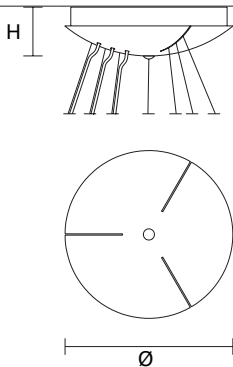
	SIZE	FINISHINGS	PRODUCT NAME
	Ø 38 cm / 15.00"	● G14	LIBE COMBO S140
	H 11 cm / 4.30"		